

- Back**
- o PushPull Power
 - o Flat Cable Connectors SEK
 - o *har-mik®*
 - o D-Sub
 - o InduCom

● **Applications**

Product details

09 03 264 6824

Backplane connector

Type	Type C
Standard/Inverse	Standard
Contact gender	Female contacts
Size	Whole size
Number of contacts	64 poles
Contact arrangement	Rows a and c
Termination	Straight solder pins
Termination length	2,9 mm
Performance Class	Performance level 2 as per IEC 60603-2
Contacts	with contacts
Board fixing	Without fixing
Coding facility	without coding facility
Current	2 A max.
Clearance/ Creepage	1.2 / 1.2 mm min.
RoHS compliant	Yes

Inquiry

Alle Rechte vorbehalten/ All rights reserved

X
Kontaktanordnung
contact arrangement

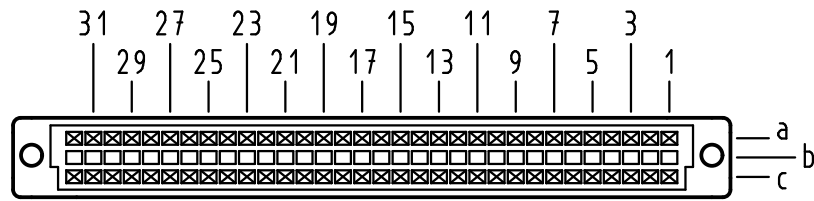

64 Einlöt-Kontakte
64 solder-contacts

- ☒ = Einlöt-Kontakt
= solder-contact
- = kinked Einlöt-Kontakt
= kinked solder-contact
- = Kontaktposition nicht belegt
= position without contact

Z
2:1

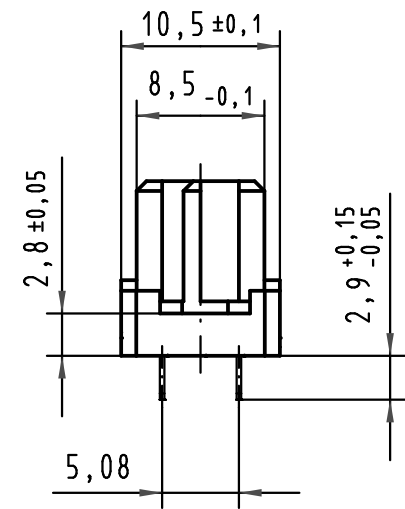

X
(Lochbild)
(board drillings)

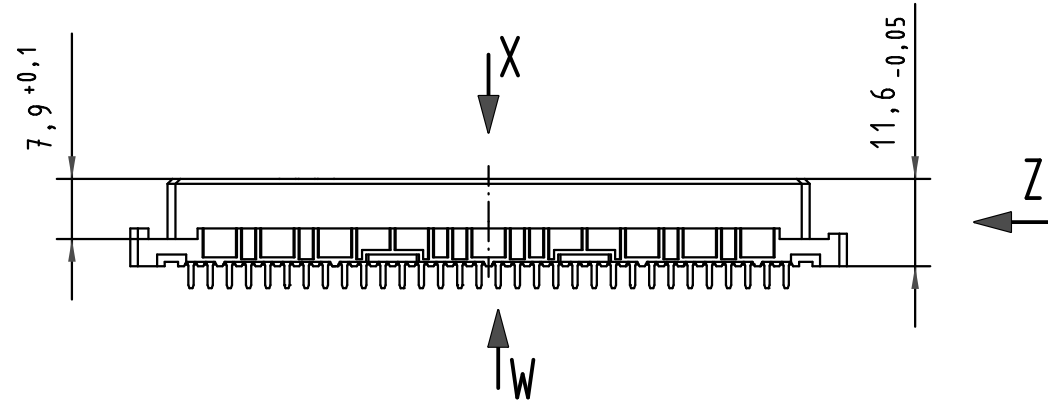
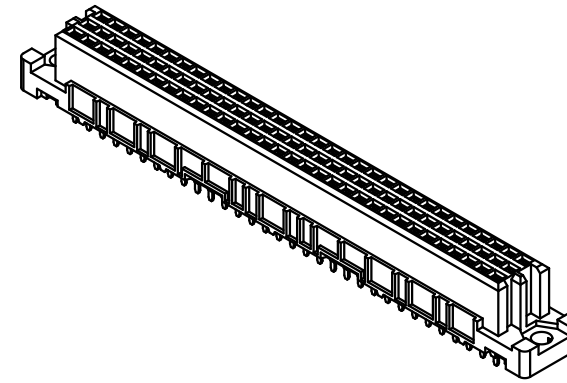
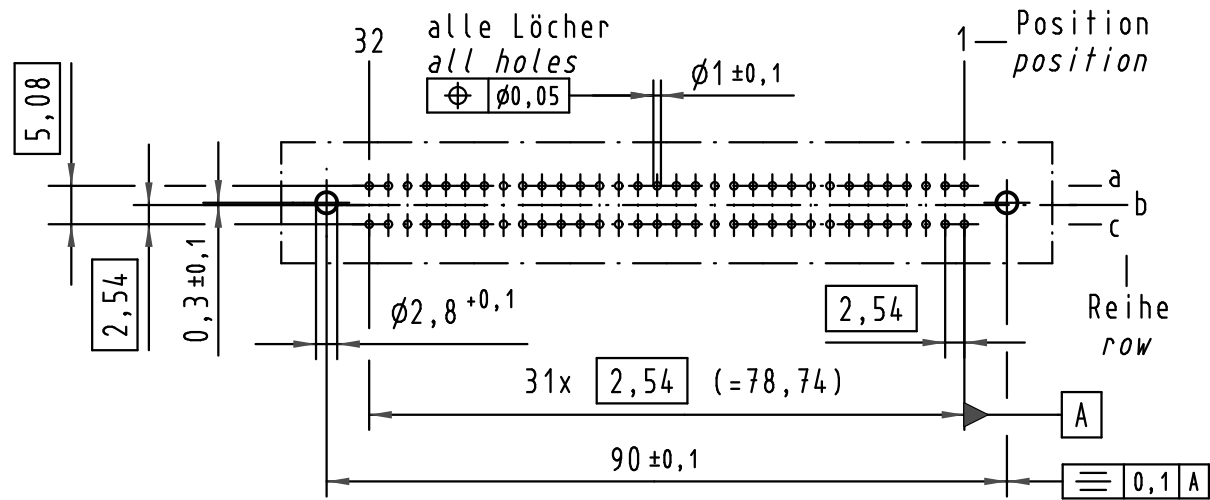

W
10:1
Querschnitt der
Lötanschlüsse:
cross-section of
solder terminations:

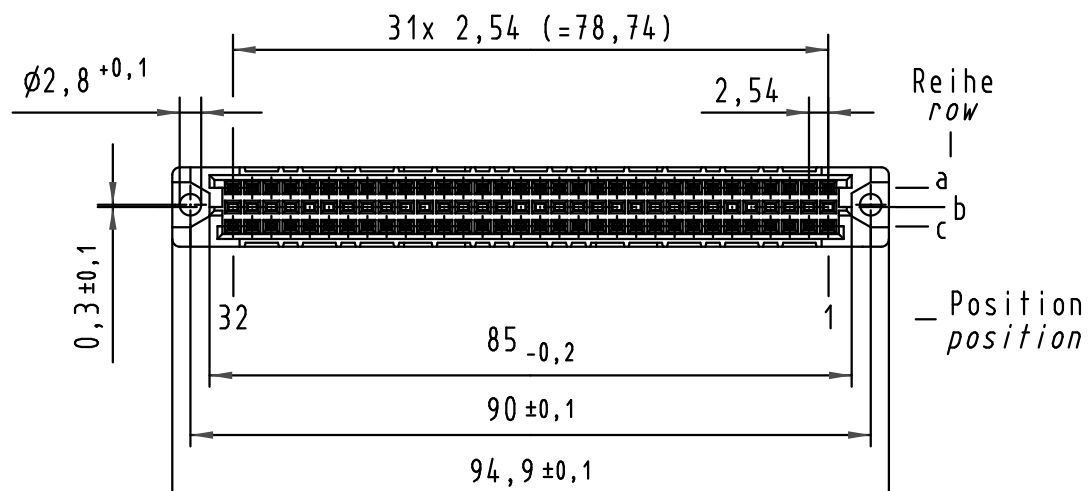
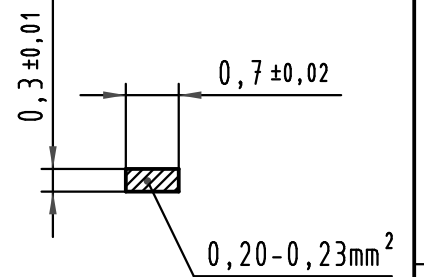

09 03 264 <u>7</u> 824	3	Au über/over Ni
09 03 264 <u>6</u> 824	2	Au über/over Ni
09 03 264 <u>2</u> 824	1	Au über/over Ni
Bestell-Nr. part-no.	Anforderungsstufe nach IEC performance level acc.to IEC	Kontaktoberfläche contact plating

All Dimensions in mm Original Size DIN A 3			Techn. Character.			Nicht tolerierte Maßel/Free size tolerances IEC 60603-2		
						har-bus C Federleiste Einlöt 2,9 , 64 pol. har-bus C female connector solder 2,9 , 64 pol.		
			Detail.	03.09.99	Rie.	Maßstab/Scale 1:1 2:1 10:1	TB 09 03 264 x824	
			Insp.	03.09.99	Pa.			
			Stand.					
34650	13.08.07	Cla					Sub.	
34158	18.01.07	LehT						
30815	19.02.02	Rie.						
26083						HARTING Electronics GmbH & Co. KG D-32339 ESPELKAMP		
Mod.	Dat.	Name						